



Installation instructions for PZ4AL-3005-00, PZ4AL-3006-00
Under Run Protective Shield Transmission Case

TOYOTA LC 200



LEXUS LX



	LC 200 (4,5TD)	LX 450d
Model year:	2015	2015
Applicability:	VDJ200L-GMTVZW	
Part Number:		Steel: PZ4AL-3005-00 Aluminium: PZ4AL-3006-00
 Weight:		Steel: 5.14 kg Aluminium: 2.73 kg
 Installation Time:		30 min

PZ4AL-03005-00, PZ4AL-3006-00

A

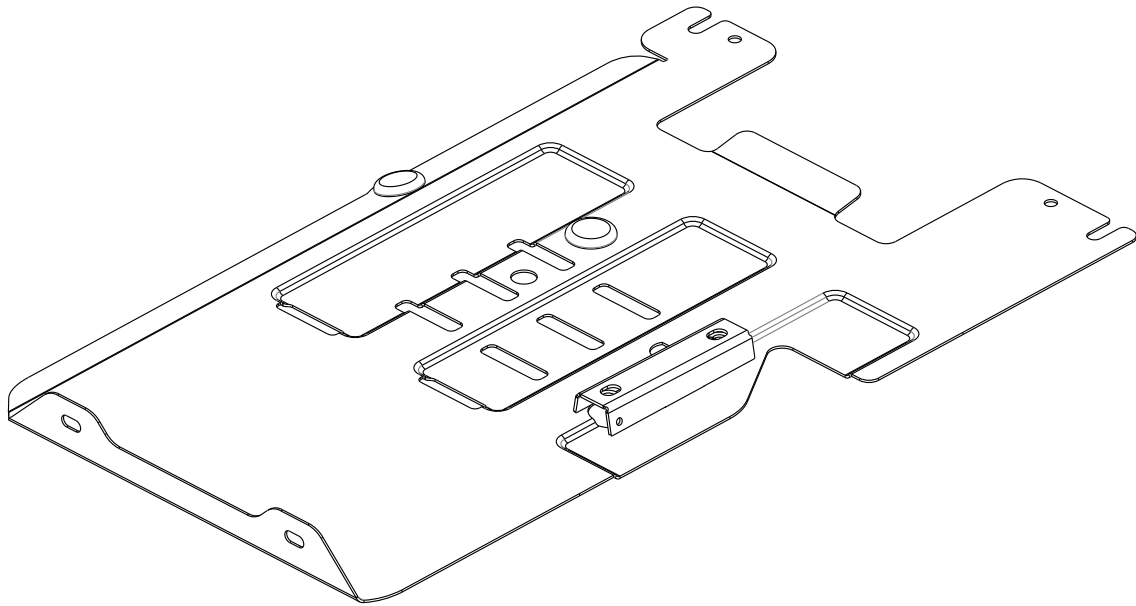

PZ4AL-03005-60

B1

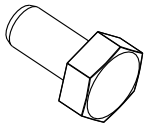

M8x20

4x

B2

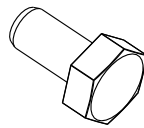

M10x1,25x20

2x

C1

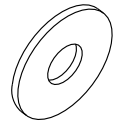

d=8

4x

C2

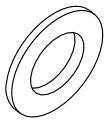

d=10

2x

D1

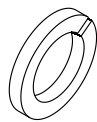

d=8

4x

D2

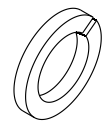

d=10

2x

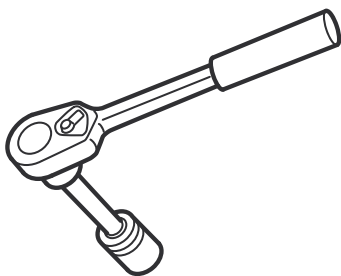

13 mm
17 mm



1

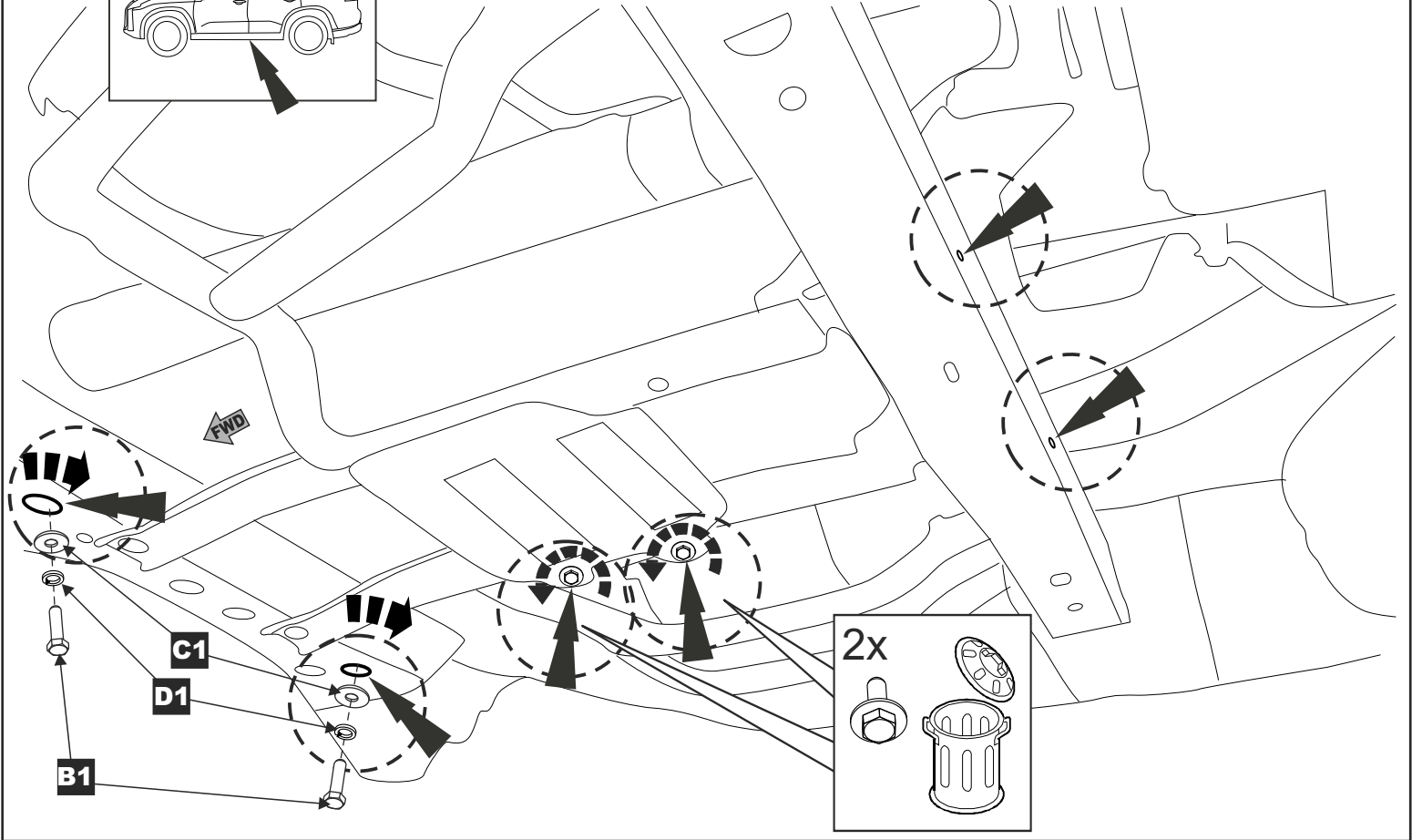
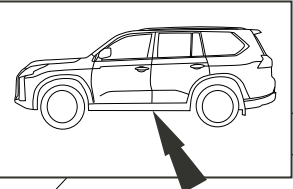

2

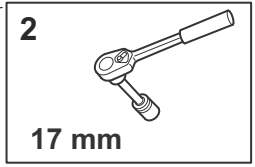
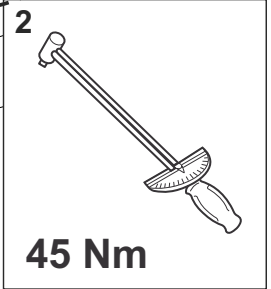
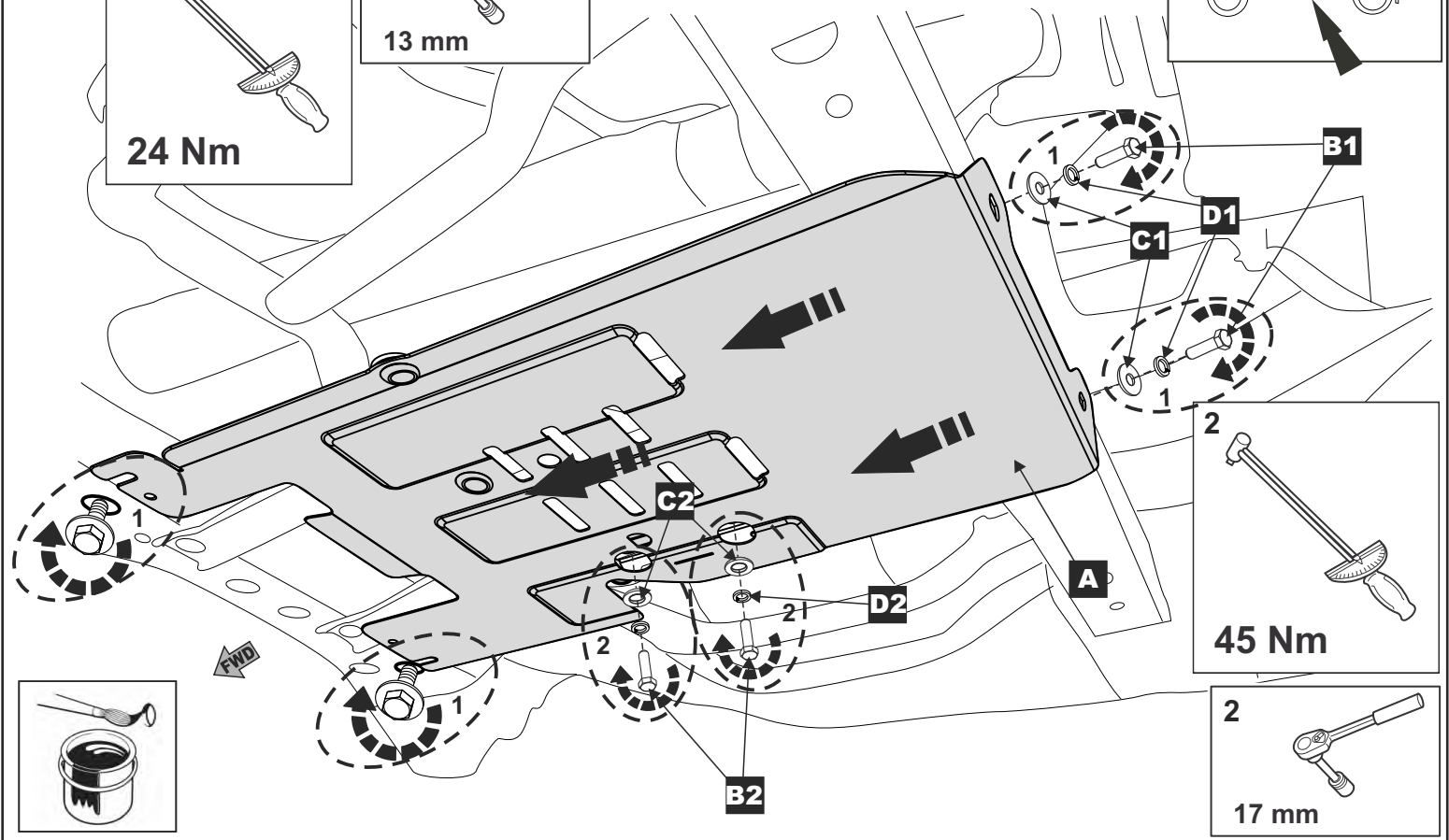
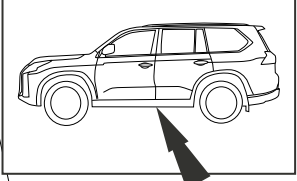
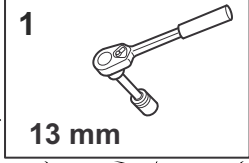

3

